



PLETSCHER®

✚ SWITZERLAND

PRODUCT CATALOG
CARRIERS
KICKSTANDS AND SYSTEM ACCESSORIES
ALLOY-FENDER



SCHUTZBLECH / FENDER / GARDE-BOUE ALUMINIUM

R 40 / R 50 / R 60 / R 65 / R 80
20" / 26" / 27.5" / 28" / 29"



optional / en option

Wersa



www.pletscher.ch

PLETSCHER®

✚ SWITZERLAND



WERSO FOR MIK-SYSTEM

WERSA SYSTEM



EASY-FIX SYSTEM





CARRIERS WITH EASY-FIX SYSTEM SWISS MADE

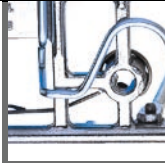

Prisma System the modern one

properties

- certified to EN ISO 11243, max load 27 kg
- aluminium-die cast
- synthese of function and design
- EasyFix for fast easy on and off or our accessories
- suitable for child seat
- integrated reflector holder 50/80mm
- adjustable front retention basket
- incl. spring clamp

apliaction

- City-Bike
- Trekking-Bike
- Gravel -Bike
- E-Bike

colour

- black
- metallic silver
- white



Dual - the carrier with 2 systems for Easy-Fix and KLICKfix accessories

properties

- certified to EN ISO 11243, max. load 27 kg
- EasyFix and KLICKfix for easy on and off or our accessories
- aluminium-die cast
- suitable for child seat
- integrated side bag holder
- reflector holder 50/80mm included
- incl. spring clamp

application

- City-Bike
- Trekking-Bike
- Gravel -Bike
- E-Bike

colour

- black
- metallic silver



Inova System the innovative one

properties

- certified to EN ISO 11243, max load 27 kg
- aluminium-die cast
- EasyFix for fast easy on and off or our accessories
- mounting points for side bag holder
- integrated pump pegs for a pump with 220-240mm
- incl. spring clamp
- reflector holder inclusive

application

- City-Bike
- Trekking-Bike
- Gravel -Bike
- E-Bike

colour

- black
- metallic silver

Advantages: High quality and durable zinc plated spring clamp. Carrier plates are aluminium injection molded without welds and torsion free. The struts fold for easy of transportation and storage.



Mercur System the dynamic one

properties

- certified to EN ISO 11243, max load 27 kg
- aluminium-die cast
- EasyFix for fast easy on and off or our accessories
- suitable for child seat
- integrated pump pegs
- side bag holder optional
- integrated reflector holder with protection bar
- inclusive spring clamp

application

- City-Bike
- Trekking-Bike
- Gravel -Bike
- E-Bike

colour

- black
- metallic silver



Apollo System with integrated backlight the exclusive one

properties

- certified to EN ISO 11243, max load 27 kg
- aluminium-die cast
- EasyFix for fast easy on and off or our accessories
- suitable for child seat
- integrated box for pump pegs
- integrated B+M backlight D'Toplight plus with sidelight
- adjustable front retraction bracket
- incl. spring clamp

application

- City-Bike
- Trekking-Bike
- Gravel -Bike
- E-Bike

colour

- black
- metallic silver



Genius System with box for pump the elegant one

properties

- certified to EN ISO 11243, max load 27 kg
- aluminium-die cast
- EasyFix for fast easy on and off or our accessories
- suitable for child seat
- integrated box for pump pegs
- integrated reflector holder 50/80mm
- incl. spring clamp

application

- City-Bike
- Trekking-Bike
- Gravel -Bike
- E-Bike

colour

- black
- metallic silver





CARRIER WITH EASY-FIX SYSTEM SWISS MADE



Genius Plus System with pump compartment the elegant one

properties

- certified to EN ISO 11243, max load 27 kg
- aluminium-die cast
- EasyFix for fast easy on and off of our accessories
- suitable for child seat
- integrated box for pump pegs
- integrated reflector holder 50/80mm
- incl. spring clamp

application

- City-Bike
- Trekking-Bike
- Gravel -Bike
- E-Bike

colour

- black
- metallic silver

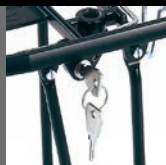

Master System ideal for travel bike

properties

- certified to EN ISO 11243, max load 27 kg
- aluminium-die cast
- EasyFix for fast easy on and off of the accessories
- suitable for child seat
- integrated reflector holder 50mm
- two adjustable front retention brackets
- inclusive spring clamp
- side bag holder optional
- lock to prevent theft for EasyFix

application

- City-Bike
- Trekking-Bike
- Gravel -Bike
- E-Bike

colour

- black
- metallic silver

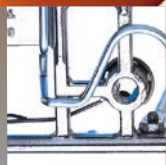

Athlete System the practical one

properties

- certified EN ISO 11243, max. load 27 kg
- aluminium-die cast
- EasyFix for easy on and off of the accessories
- suitable for child seat
- integrated reflector holder 50/80mm
- incl. spring clamp

application

- City-Bike
- Trekking-Bike
- Gravel -Bike
- E-Bike

colour

- black
- metallic silver

Advantages: High quality and durable zinc plated spring clamp. Carrier plates are aluminium injection molded without welds and torsion free. The struts fold for easy of transportation and storage.



CARRIER WITH WERSA SYSTEM

Athlete System PS the all-rounder

properties

- certified to EN ISO 11243, max load 27 kg
- aluminium-die cast
- EasyFix for easy on and off of the accessories
- suitable for child seat
- integrated reflector holder 50/80mm
- incl. spring clamp
- integrated pump pegs for pumps 220-240mm

application

- City-Bike
- Trekking-Bike
- Gravel -Bike
- E-Bike

colour

- black
- metallic silver



Wersa - System Carrier the light one with system

properties

- certified to EN ISO 11243, max load 27 kg
- aluminium-die cast
- integrated Wersa - System for easy on and off of the accessories
- integrated reflector holder 50/80mm
- optional with pump pegs
- optional with spring clamp
- optional with stay end plates

application

- City-Bike
- Trekking-Bike
- Gravel -Bike
- E-Bike

colour

- black
- metallic silver
- chrom coloured
- titan



Wersa Y - System carrier

with aluminium tube struts for 26", 27.5", 28" and 29" bicycles

properties

- certified to EN ISO 11243, max load 27 kg
- aluminium-die cast
- integrated Wersa - System for easy on and off of the accessories
- elegant aluminium tube struts for 26", 27.5", 28" und 29"
- integrated reflector holder 50/80mm
- optional with pump pegs
- optional with spring clamp

application

- City-Bike
- Trekking-Bike
- Gravel -Bike
- E-Bike

colour

- black





STANDARD CARRIER SWISS MADE



Werso for MIK - System ideal for the touring bike

properties

- certified to EN ISO 11243, max load 27 kg
- aluminium-die cast
- integrated MIK - System for easy on and off of the accessories
- integrated reflector holder 50/80 mm
- MIK - adapter with anti-theft device

apliation

- City-Bike
- Trekking-Bike
- Gravel -Bike
- E-Bike

colour

- black
- metallic silver

Advantages: High quality and durable zinc plated spring clamp. Carrier plates are aluminium injection molded without welds and torsion free. The struts fold for easy of transportation and storage.



Wersa - System



Easy - Fix - System





STANDARD CARRIER SWISS MADE



Athlete 2B the front - or rear- carrier

properties

- front- or rear carrier
- certified to EN ISO 11243, max load 10 kg
- aluminium-die cast
- incl. spring clamp and
- incl. stay end plates
- incl. reflector holder

application

- City-Bike
- Trekking-Bike
- E-Bike

colour

- black
- metallic silver



Athlete 4B the proven one

properties

- certified EN ISO 11243, max. load 27 kg
- aluminium-die cast
- incl. spring clamp
- incl. stay end plates
- incl. reflector holder 50/80mm

application

- City-Bike
- Trekking-Bike
- E-Bike

colour

- black
- metallic silver

Advantages: High quality and durable zinc plated spring clamp. Carrier plates are aluminium injection molded without welds and torsion free. The struts fold for easy of transportation and storage.



CLASSIC AND ECONOMY MODEL

Modell CS the classic one

properties

- certified to EN ISO 11243, max load 10 kg
- aluminium-die cast
- incl. spring clamp
- mounting on cross or double clamp
- reflector holder integrated 50/80

application

- City-Bike
- Trekking-Bike
- E-Bike

colour

- black
- metallic silver
- polished



Quattro the junior

properties

- certified to EN ISO 11243, max load 27 kg
- aluminium-die cast
- integrated reflector holder 50mm for easy mount of the backlight
- incl. spring clamp

application

- City-Bike
- Trekking-Bike
- Gravel -Bike
- E-Bike
- child seat

colour

- black
- metallic silver

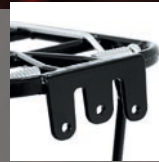



CARRIER WITH QUICK RACK RELEASE SWISS MADE



Orion Orion Fender 60mm

properties

- certified to EN ISO 11243, max load 8 kg
- adjustable tilt angle by scanning
- suitable for full suspension bike
- integrated box for tools, pump, mobile etc.
- integrated reflector holder for smart light LED R L403
- for seat posts with a diameter of 24 - 35 mm
- option aluminium fender
- inclusive strap

application

- City-Bike
- Trekking-Bike
- Gravel -Bike
- MTB

colour

- black
- metallic silver



Quick-Rack System - for Easy Fix System for bikes without rear wheel suspension

properties

- certified to EN ISO 11243, max load 27 kg
- aluminium-die cast
- EasyFix for easy on and off of the accessories
- suitable for child seat
- integrated reflector holder 50/80mm
- incl. spring clamp
- incl. stay end plates
- easy on and off with cam sleeve and quick release for seat posts with a diameter of 24 - 35 mm

application

- City-Bike
- Trekking-Bike
- Gravel -Bike
- MTB

colour

- black
- metallic silver

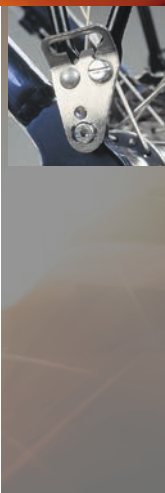

Quick-Rack 4B for bikes without rear wheel suspension

properties

- certified to EN ISO 11243, max load 27 kg
- aluminium-die cast
- incl. spring clamp
- incl. adjustable stay end plates
- reflector holder 50/80mm anschraubbar
- reflector optional
- easy on and off with cam sleeve and quick release for seat posts with a diameter of 24 - 35 mm

application

- City-Bike
- Trekking-Bike
- Gravel -Bike
- MTB

colour

- black
- metallic silver

Advantages: High quality and durable zinc plated spring clamp. Carrier plates are aluminium injection molded without welds and torsion free. The struts fold for easy of transportation and storage.



easy on - easy off

Quick-Rack Suspension for full suspension bikes

properties

- certified to EN ISO 11243, max load 10 kg
- aluminium-die cast
- suitable for full suspension bike
- integrated reflector holder 50/80mm for easy on and off of the backlight
- incl. tension strap
- easy on and off with cam sleeve and quick release for seat posts with a diameter of 24 - 35 mm

application

- MTB
- Fully

colour

- black



QUICK RACK DEMO





easy on and off in 10 seconds

UNIQUE













CARRIER SPECIFICATION





| | Genius | Prisma | Inova | Mercur System | Apollo |
|--|---|--|---|---|---|
| |  |  |  |  |  |
| certified to EN ISO 11243 | X | X | X | X | X |
| frame mount to braze-ons or cross plate | X | X | X | X | X |
| number of struts | 4 | 4 | 4 | 4 | 4 |
| struts mount on rear drop outs | X | X | X | X | X |
| struts mounted on axle | - | - | - | - | - |
| struts mounted on cam sleeve | - | - | - | - | - |
| strut length L1, rear assembly (mm) | 320/26" 330/28"/29" - | 300/26" 310/26"/28" 320/28"/29" | 310/26" 330/28" - | 320/26" 330/26"/28" 340/28"/29" | 340/28"/29" - - |
| strut length L2, front assembly (mm) | 354/26" 363/28"/29" | 345/26" 354/26"/28" 363/28"/29" | 345/26" - 363/28"/29" | 343/26" 354/26"/28" 363/28"/29" | 380/28"/29" - - |
| strut length L1, front assembly (mm) | - - | - - | - - | - - | - - |
| pump pegs/box for pumps with length (mm) | 200-215 | - | 225-240 | 200-215 | 225-240 |
| carrier plate aluminium die cast/ GD 226 (AlSi9Cu3) | X | X | X | X | X |
| quick rack-quick release polyamid 25% fiberglas | - | - | - | - | - |
| springs and axles spring steel zinc plated | X | X | X | X | X |
| bolts and nuts stainless steel | - | X | - | X | - |
| rivets aluminium | X | X | X | - | X |
| powder coated | X | X | X | X | X |
| colours | black/silver | black/silver | black/silver | black/silver | black/silver |
| weight carrier (g) | 840 | 850 | 860 | 820 | 990 |
| dimension carrier plate (mm) | 346x140 | 382x130 | 383x138 | 390x140 | 421x142 |
| easy fix-system with lock | X | X | X | X | X |
| Pletscher quick rack-quick release for saddle post diameter 24 till 35 mm | - | - | - | - | - |
| Wersa System | - | - | - | - | - |
| pannier brackets | - | X | X | X | - |
| anti theft locking system | - | - | - | - | - |
| spring clamp | X | X | X | X | X |
| strap | - | - | - | - | - |
| front retention non adjustable | X | - | - | X | - |
| front retention adjustable | - | X | X | - | X |
| max. load to EN ISO (kg) | 27 | 27 | 27 | 27 | 27 |
| suitable for child seat | X | X | X | X | X |
| suitable for full suspension bike | - | - | - | - | - |
| reflector bracket | X | X | X | X | - |
| backlight | - | - | - | - | X |
| pump pegs / box for pumps | - | - | X | X | X |
| pump | optional | - | optional | optional | optional |



| Master | Athlete System | Genius Plus | Wersa System | Werso for MIK - System | Athlete 2B | Athlete 2B mount on axle | Athlete 4B | Quattro |
|--|---|---|---|---|--|---|---|---|
|  |  |  |  |  |  |  |  |  |
| X | X | X | X | X | X | X | X | X |
| X | X | X | X | X | X | X | X | X |
| 4 | 4 | 4 | 4 | 4 | 2 | 2 | 4 | 4 |
| X | X | X | X | X | X | X | X | X |
| - | - | - | - | - | X | X | - | - |
| - | - | - | - | - | - | - | - | - |
| 310/26" 320/26"/28" 330/28"/29" | 310/26" 320/26"/28" 330/28"/29" | 310/26" 320/26"/28" 330/28"/29" | 310/26" 320/26"/28" 330/28"/29" | 310/26" 320/26"/28" 330/28"/29" | 340/26" 360/28"/29" - | 340/26" 360/28"/29" - | 310/26" 320/26"/28" 330/28"/29" | 315/24" 335/26"/28" |
| 345/26" 354/26"/28" 363/28"/29" | 345/26" 354/26"/28" 363/28"/29" | 345/26" 354/26"/28" 363/28"/29" | 345/26" 354/26"/28" 363/28"/29" | 345/26" 354/26"/28" 363/28"/29" | - - - | - - - | 345/26" 354/26"/28" 363/28"/29" | - - - |
| - | - | - | - | - | 360/26" 380/28"/29" | 360/26" 380/28" | - | - |
| - | - | 225-240 | - | - | - | - | - | - |
| X | X | X | X | X | X | X | X | X |
| - | - | - | - | - | - | - | - | - |
| X | X | X | X | X | X | X | X | X |
| - | X | X | - | - | - | - | - | - |
| X | X | X | X | X | X | X | X | X |
| X | X | X | X | X | X | X | X | X |
| black/silver | black/silver | black/silver | black/silver | black/silver | black/silver | black/silver | black/silver | black/silver |
| 870 | 800 | 1100 | 509 | 520 | 515 | 515 | 670 | 610 |
| 395x142 | 340x140 | 390x160 | 340x120 | 340x120 | 360x130 | 360x130 | 362x140 | 320x130 |
| X | X | X | - | - | - | - | - | - |
| - | - | - | - | - | - | - | - | - |
| - | - | - | X | - | - | - | - | - |
| X | - | - | - | - | - | - | - | - |
| X | - | - | - | - | - | - | - | - |
| X | X | X | X | - | X | X | X | X |
| - | - | - | - | - | - | - | - | - |
| - | - | X | X | - | - | - | X | X |
| X | X | - | - | - | X | X | - | - |
| 27 | 27 | 27 | 27 | 27 | 10 | 10 | 27 | 27 |
| X | X | X | - | - | - | - | - | - |
| - | - | - | - | - | - | - | - | - |
| X | X | X | X | X | X | X | X | X |
| - | - | - | - | - | - | - | - | - |
| - | - | X | - | - | - | - | - | - |
| - | optional | optional | optional | - | - | - | - | - |



CARRIER SPECIFICATION

| | Orion | Quick-Rack System | Quick-Rack Suspension | Quick-Rack 4B | Dual |
|--|---|--|---|---|---|
| |  |  |  |  |  |
| certified to EN ISO 11243 | X | X | X | X | X |
| frame mount to braze-ons or cross plate | - | - | - | - | X |
| number of struts | 0 | 4 | 2 | 4 | 4 |
| struts mount on rear drop outs | - | - | - | - | X |
| struts mounted on axle | - | - | - | - | - |
| struts mounted on cam sleeve | - | X | X | X | - |
| strut length L1, rear assembly (mm) | - | 310/26" 320/26"/28" 330/28"/29" | 330 | 310/26" 320/26"/28" 330/28"/29" | 300/26" 310/26"/28" 320/28"/29" |
| strut length L2, front assembly (mm) | - | 345/26" 354/26"/28" 363/28"/29" | - | 345/26" 354/26"/28" 363/28"/29" | 345/26" 354/26"/28" 363/28"/29" |
| strut length L1, front assembly (mm) | - | - | - | - | - |
| pump pegs/box for pumps with length (mm) | 225-240 | - | - | - | - |
| carrier plate aluminium die cast/ GD 226 (AlSi9Cu3) | X | X | X | X | X |
| quick rack-quick release polyamid 25% fiberglas | X | X | X | X | - |
| springs and axles spring steel zinc plated | - | X | - | X | X |
| bolts and nuts stainless steel | X | X | X | X | X |
| rivets aluminium | X | X | X | X | X |
| powder coated | X | X | X | X | X |
| colours | black/silver | black/silver | black/silver | black/silver | black/silver |
| weight carrier (g) | 860 | 1060 | 570 | 940 | 1050 |
| dimension carrier plate (mm) | 290x130 | 362x140 | 332x116 | 362x140 | 373x145 |
| easy fix-system with lock | - | X | - | - | X |
| Pletscher quick rack-quick release for saddle post diameter 24 - 35mm | X | X | X | X | - |
| Wersa System | - | - | - | - | - |
| pannier brackets | - | - | - | - | X |
| anti theft locking system | - | - | - | - | - |
| spring clamp | - | X | X | X | X |
| strap | X | - | - | - | - |
| front retention non adjustable | X | - | - | X | - |
| front retention adjustable | - | X | - | - | - |
| max. load to EN ISO (kg) | 8 | 27 | 10 | 27 | 27 |
| suitable for child seat | - | X | - | - | X |
| suitable for full suspension bike | X | - | X | - | - |
| reflector bracket | X | X | X | X | X |
| backlight | - | - | - | - | - |
| pump pegs / box for pumps | X | - | - | - | - |
| pump | optional | - | - | - | - |



CARRIER MOUNTING PARTS

universal carrier mount for weld on cross plate

material
• steel zinc plated

colour
• powder coating black or shiny

specification
• length: 148 or 178mm

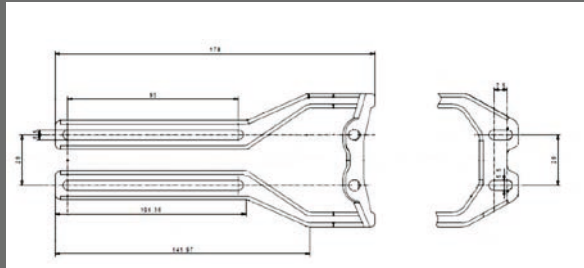

carrier mount for braze-ons flat - for carriers with 4 struts

material
• stainless steel

colour
• powder coating black or shiny

specification
• length: 145/165/205/ 235mm

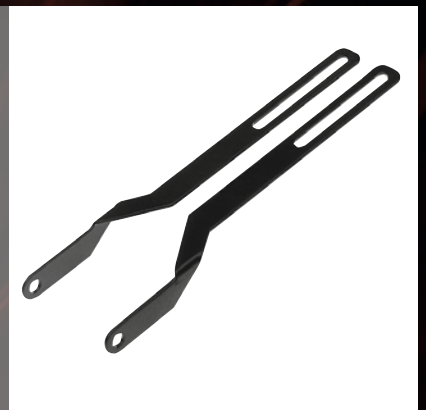
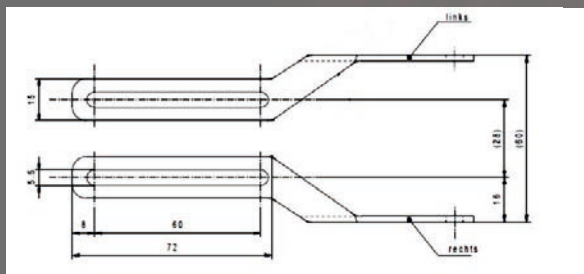

steel - carrier mount for braze-ons flat and reinforced - for carriers with 2 struts

material
• stainless steel

colour
• powder coating black or shiny

specification
• length 145mm

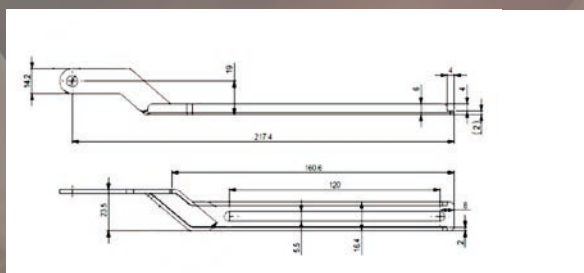



CARRIER MOUNTING PARTS



standard aluminium carrier mount for braze-ons

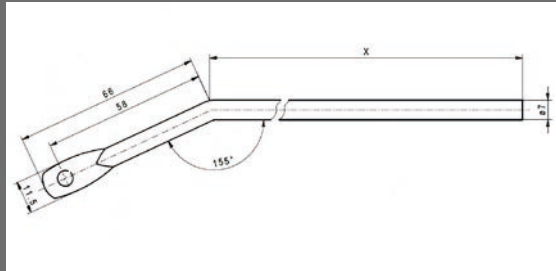

- material
- aluminium \varnothing 7.0mm
- colour
- powder coating black or shiny
- specification
- diameter: 7mm
 - length: 66/85; 66/133; 66/185; 66/230 mm



carrier mount for braze-ons for carrier Vario

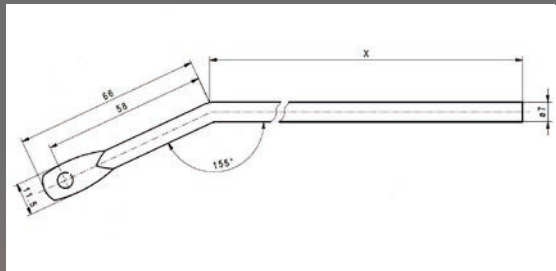

- material
- aluminium \varnothing 7.0mm
- colour
- powder coating black or shiny
- specification
- diameter: 7mm
 - length: 66/85; 66/133; 66/185mm



stainless steel carrier mount for cross plate

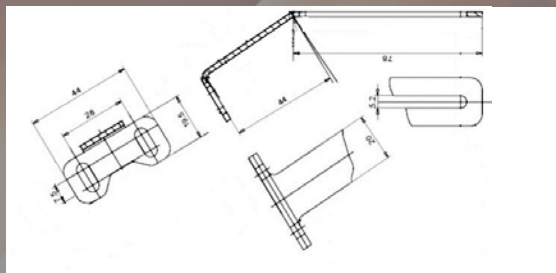

- material
- stainless steel
- colour
- powder coating black or shiny
- dimension
- length: 78mm

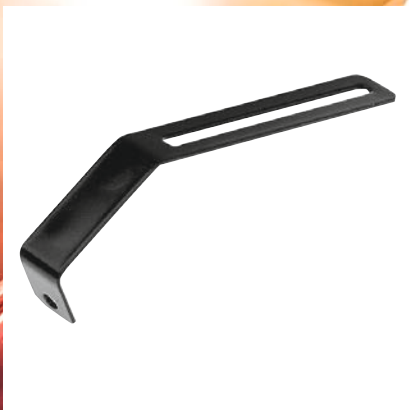

stainless steel carrier mount for rear brake bolt

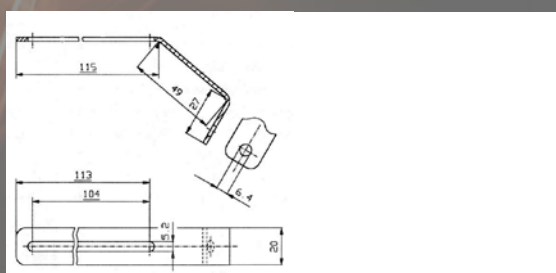

- material
- stainless steel
- colour
- powder coating black or shiny
- specification
- length: 115 and 155mm



carrier mount stainless steel for front brake mount

material

- stainless steel

colour

- powder coating black or shiny

specification

- length 122mm

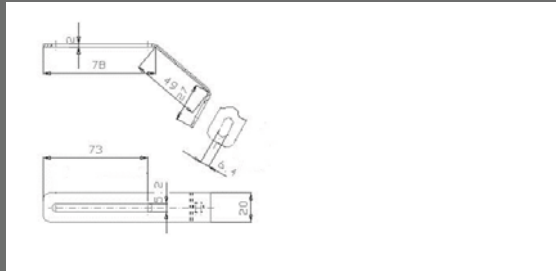

adapter angle

stainless steel

material

- stainless steel

colour

- shiny

hole distance center: 28mm

dimension: 62x20x25mm

diameter long hole: 5mm

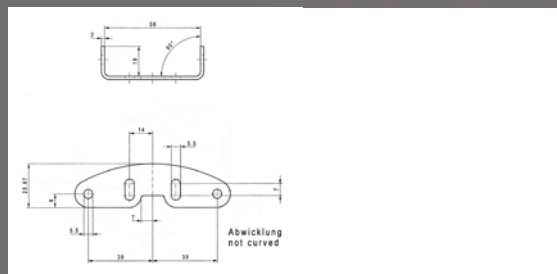

double clamp

for frame mounting

material

- steel, zinc plated

colour

- shiny

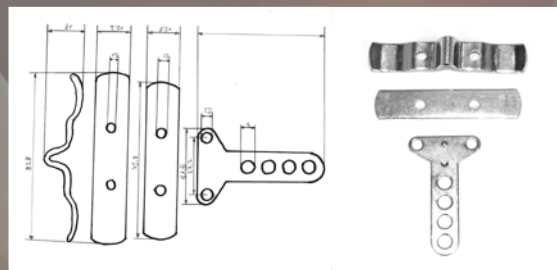



stay end plates

for Quick-Rack with cam sleeve

material

- stainless steel

colour

- shiny
- black

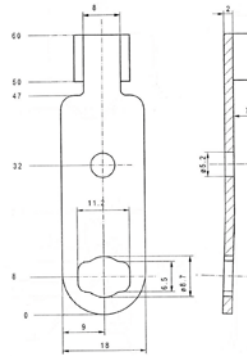

stay end plates standard

for Quick-Rack with cam sleeve

material

- stainless steel

colour

- shiny
- black

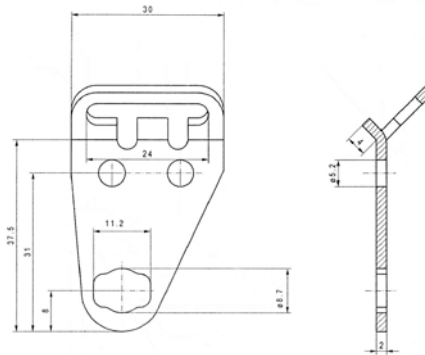

stay end plates adjustable

adjustable für Quick-Rack with cam sleeve

material

- stainless steel

colour

- shiny
- black

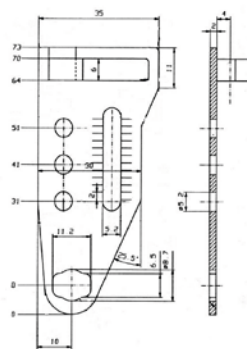

stay end plates adjustable

for mounting on axle

material

- stainless steel
- shiny , black

application

- for mounting on axle
- for carriers with 2 struts

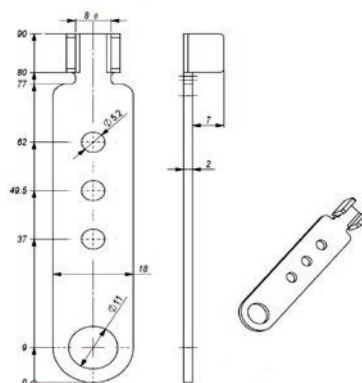



CARRIER ACCESSORIES



cam sleeve for Quick-Rack

application

- Quick-Rack Full-Suspension
- Athlete 4B quick rack
- Athlete System quick rack

material

- stainless steel

colour

- shiny



fastener for u-lock

4 struts

application

- suitable for all carriers with 4 struts
 - suitable for fastener for u-lock from 75 150mm
- dimension metal rail: 233x25mm
diameter for fastener for u-lock till 16mm

material

- aluminium

colour

- metallic-silver



pannier bracket (set)

universal

application

- suitable for all carriers with 4 struts

delivery

- pannier brackets left and right
- incl. mounting parts

material

- aluminium

colour

- black or metallic-silver



pannier bracket

Master

application

- suitable for carrier Master

delivery

- pannier brackets left and right
- incl. mounting parts

material

- aluminium

colour

- black or metallic-silver



pannier brackets allrounder

application

- Genius
- Athlete 2B/ 4B/ PSP
- Master
- Mercur System

• Athlete System

material

- steel
- black/metallic-silver

delivery

- pannier brackets left and right
- incl. mounting parts



pannier bracket (pair) 3rd strut

application

- suitable for all carriers with 4 struts

delivery

- pannier brackets left and right
- incl. mounting parts

material

- aluminium
- black/metallic-silver



Plateo backlight XBA 80mm / XS 80mm

suitable for carrier

- Inova
- with Dynamo (XS)
- with Accu (XBA)

delivery

- Plateo backlight
- Pletscher backlight optional
- mounting parts optional

material

- plastic

colour

- back side: black
- front side: red reflective



pumps SKS / Zéfal

pumps suitable for

- Genius
- SKS (200-215mm) Sclaverland/ Dunlop
- Zéfal (200-215mm) Sclaverland/ Dunlop/ car valve

pump suitable for

- Athlete and Apollo
- SKS (225-240mm) car valve
- SKS (200-215mm) Sclaverland/ Dunlop
- SKS (200-215mm) Sclaverland/ Dunlop/ car valve





CARRIER ACCESSORIES



side bag holder for Mercur System

application
• Mercur System

material
• aluminium

delivery
• pair inclusive mounting
parts

colour
• black or metallic silver



side bag holder for Inova System

application
• Inova System

material
• aluminium

delivery
• pair inclusive mounting
parts

colour
• black or metallic silver



side bag holder for Prisma System

application
• Prisma System

material
• aluminium

delivery
• pair inclusive mounting
parts

colour
• black
• white
• metallic silver



ACCESSORIES

child seat Wallaby for Easy Fix System

properties

- adjustable foot rest
- adjustable back rest
- easy to mount and take off
- certified to EN 14344, max. load 22 kg
- preassembled adapter with spring suspension mounted in the delivery
- suitable for all carriers with easy fix system

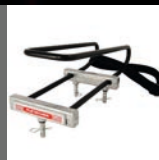

child seat adapter

properties

- inclusive safty strap and 3 safty pins
- certified to EN 14344, max.load 22 kg
- suitable for all carriers with easy fix system

pipe distance outside

Polysport and Wallaby: 112 mm

Römer: 121 mm

OK Baby: 103 mm

2 different adapter suitable to:

- Pletscher Wallaby and Polysport
- Römer „Jockey“ and „Relax“



hard shell case

the compact one

properties

- hard shell case with lock
- metal adapter for easy fix-System

specification

- large volume
360x240x180 mm
- weight incl. adapter 1370g

application

- suitable for all carriers with easy fix system or Wersa system





ACCESSORIES



Alu - basket black or silver very stable

properties

- suitable for shopping
- integrated handle with protection
- plastic adapter for easy-fix system or aluminium adapter for Wersa system

specification

- L 400 mm; B: 240 mm; H: 220 mm
H front: 190 mm
- weight incl. adapter 1350 g
- max. weight load 8kg

application

- suitable for all Pletscher carriers with easy-fix or Wersa system



bike basket Deluxe XXL the big one

properties

- suitable for Scout school bags
- integrated handle with handle protection
- plastic adapter for easy-fix system or aluminium adapter for Wersa system

specification

- large volume
L 335 mm; W 210 mm; H back 270 mm
H front 170 mm
- weight incl. adapter 1650g
- max. load 8kg

application

- suitable for all carriers with easy-fix or Wersa system

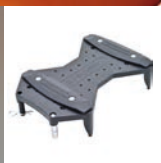

bike basket Deluxe the modern one

properties

- integrated handle with handle protection
- plastic adapter for easy-fix system or aluminium adapter for Wersa system

specification

- L 245 mm; B 315 mm; H back 215 mm
H front 120 mm
- weight incl. adapter 1400g
- max. load 8kg

application

- suitable for all carriers with easy-fix or Wersa system

Advantages: Fast and simple assembly and disassembly. Durable materials. Useful details. Modern designs.



easy on - easy off

bike basket Standard

properties

- integrated handle with handle protection
- plastic adapter for easy fix System or aluminium adapter for Wersa System

specification

- large volume
L: 235 mm; W:305 mm; H front: 180 mm;
H back: 225mm
- weight incl. adapter 1370g
- max. load 8kg

application

- suitable for all carriers with easy-fix or Wersa system



bike basket Rattan

properties

- integrated handle with handle protection
- Fashionable and weatherproof plastic straps
- brown/black

specification

- L: 235 mm; W:305 mm; H front: 180 mm;
H back: 225mm
- weight incl. adapter 2260 g
- max. load 8 kg

application

- suitable for all carriers with easy-fix or Wersa system



bike basket Flash

properties

- integrated handle with handle protection
- Coarse-meshed body with fine-meshed bottom

specification

- L: 235 mm; W:305 mm; H front: 180 mm;
H back: 225mm
- weight incl. adapter 1440 g
- max. load 8 kg

application

- suitable for all carriers with easy-fix or Wersa system





Accessories



Easy - Fix plastic Adapter

properties

- plastic plate with 3 Pins and 2 bridges
- suitable for carriers with Easy Fix System
- additional safty potter pin

application

- suitable for all bags, baskets and crates - but not for hard shell case

specification

- dimension 230x165 mm



Easy-Fix Aluminium Adapter

properties

- Aluminium Adapter with 3 pins
- suitable for carriers with Easy Fix System
- additional 3 safty potter pins

application

- suitable for hard shell case and crates

specification

- dimension 220x90 mm



Wersa Aluminium Adapter

properties

- aluminium adapter with plastic system
- suitable for Wersa System

application

- suitable for all bags, baskets and crates - but not for hard shell case

specification

- dimension 190 x 135 mm

Advantages: Fast and simple assembly and disassembly. Durable materials. Useful details. Modern designs.



easy on - easy off

bag Mini the small one

properties

- helmet net
- splash water proof; durable
- integrated handle
- plastic adapter for Easy-Fix System or aluminium Adapter for Wersa System

specification

- dimension 300x150x160 mm

application

- suitable for all carriers with easy-fix or Wersa system

colour

- black, blue, olive, red



bag Ascona the sportive one

properties

- helmet net
- durable
- integrated handle
- rain cover

specification

- dimension 350x220x150 mm

application

- suitable for all carriers with easy-fix or Wersa system



bag Basilea the large one

properties

- reflector stripes
- helmet net; durable
- with integrated handle and shoulder carrying strap
- high adjustable for increasing the volume
- side pockets foldable
- rain cover

specification

- dimension 350x180x250 mm

application

- suitable for all carriers with easy-fix or Wersa system





ACCESSORIES



bag Zurigo the practical one

properties

- reflector stripes
- splash water proof; durable
- integrated handle and shoulder strap
- rain cover

application

- suitable for all Pletscher carriers with easy - fix System - or Wersa System

specification

- volume 9-12l
- dimension 320x150x190 mm



ROMA Bag for Orion Wersa The lightweight sporty bag

properties

- plastic adapter for Easy Fix-System or aluminium adapter for Wersa System
- with integrated handle
- reflector stripes
- splash water proof + rain cover
- durable

specification

- volume max. 6 l
- dimension 300 x 150 x 170 mm
- H (back) = 170 mm
- H (front) = 110 mm
- weight without adapter: 520 g

application

- suitable for all carriers with easy - fix System - or Wersa System

colour

- black/grey

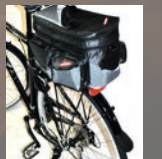

bag Turicum for E-Bike Accu

properties

- reflektor stripes; rain cover
- velcro fastening to secure Accu
- integrated handle and shoulder strap
- plastic adapter for easy fix-system or aluminium adapter for Wersa system

specification

- dimension 360x150x190 mm

Advantages: Fast and simple assembly and disassembly. Durable materials. Useful details. Modern designs.



easy on - easy off

side bag Brisi

properties

- large, wide-opening main pocket
- closed bag with cover pocket
- reflector stripes
- durable and protect against dirt and water
- adjustable push fit fastener
- adjustable fixing guide 110 - 230mm

specification

- dimension 240x140x330 mm

application

- suitable for all carriers with side bag holder



double -side bag Traveller the practical one

properties

- closed pocket with lid pocket
- reflector stripes
- durable and splash proof
- Velcro closure at the back for fixing to S trut
- adjustable push fit fastener

specification

- dimension 300x370x130 mm

application

- suitable for all carriers



side bag Bern durable

properties

- water proof - hand stitched
- reflector stripes

specification

- dimension 310x120x420 mm
- weight: 1060 g
- adjustable fixing guide 110 - 230mm

material

- new truck blache

application

- suitable for all carriers

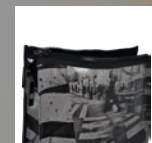



ACCESSORIES



Bike-Shopper and Easy Snap coupling

The off-road capability

properties Bike Shopper:

- foldable frame
- off-road capability
- Easy-Snap coupling optional

specification

- wheel diameter 250mm
- max. load 40kg

properties Easy Snap coupling:

- reflector optional - easy to mount
- max. load 40 kg

application

- suitable for carrier Athlete System, Athlete System with pump pegs, Genius and Genius Plus



Saddle bag Arosa

the sportive one

properties

- reflector stripes
- splash water proof
- incl. mounting parts

specification

- dimension 100x130x90 mm

application

- saddle post-Ø 25.4-31.6 mm



Saddle bag Davos

the sportive one

properties

- reflector stripes
- splash water proof
- incl. mounting parts

specification

- dimension 70x200x80 mm

application

- saddle post-Ø 25.4-31.6 mm

Advantages: Fast and simple assembly and disassembly. Durable materials. Useful details. Modern designs.



easy on - easy off

Inlay Bag for Shopping basket Standard and Deluxe

properties

- splash water proof
- durable

colour

- black

dimension

ground: 290 mm x 220 mm
cover: 380 mm x 280 mm
high: 210 mm

application

- suitable for basket Standard and Deluxe



Inlay Bag Deluxe For Shopping Basket Standard and Deluxe

properties

- splash water proof, very durable
- hand stitched
- weight 360 g

colour

- black/ grey

dimension

ground: 290 mm x 220 mm
cover: 380 mm x 280 mm
high: 210 mm

material

- new truck blache

application

- suitable for baskets Standard and Deluxe



Inlay Bag for Alu - basket For Shopping Basket Standard and Deluxe

properties

- splash water proof, very durable
- hand stitched
- weight 360 g
- with additional plastic bottom

colour

- black/ grey

dimension:

ground: 390 mm x 230 mm
cover: 445 mm x 300 mm, high: 170 mm

material

- new truck blache

application

- suitable for Alu - basket





ALLOY - FENDER - CARRIER - SYSTEM



Alloy - Fender - Carrier - System

width: 40mm, 50mm, 60mm, 65mm, 80mm

properties

- one piece round profile A aluminium EN AW - 6060
- width: 40mm, 50mm, 60mm, 65mm, 80mm
- integrated cable conduit
- robust, vandal proof & durable
- optional: side bag holder: max. load per side 8 kg

application

- City-Bike
- Trekking-Bike

bend radius

- 24 - 29 inch



Orion Wersa

The seat post carrier with wersa-system for bags

properties

- certified to EN ISO 11243, max load 8 kg
- aluminium-die cast
- adjustable tilt angle by scanning
- suitable for full suspension bike
- integrated Wersa-System for easy on and off of the accessories
- for seat posts with a diameter of 24 - 35 mm

application

- MTB-Bike
- racing bike
- Gravel-Bike

colour

- black
- metallic silver

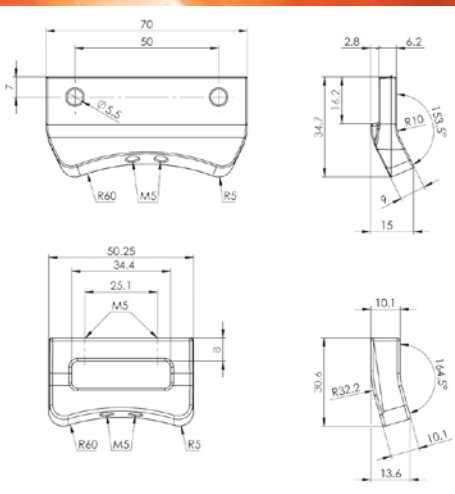

Mounting bracket Wersa on fender

The elegant integration

The wersa carrier can be mounted directly with the new mounting parts on the robust aluminium fender (width 60, 65, 80 mm).

material

- aluminium-die cast

colour

- powder coating black



FENDER SPORT

Fender Sport

width 50mm; 60mm, 65mm

properties

- round profile aluminium EM AW-6060
- length front: 400mm / rear: 550mm
- integrated cable conduit
- clamping angle for the front fender
- robust & durable

application

- City-Bike
- Trekking-Bike
- Gravel-Bike



FenderSport
for 26"/27.5"/28"/29"
width 50 / 60 / 65 mm





ESGE-KICKSTANDS SWISS MADE



Standard center kickstand

properties

- push spring movement
- length 265 - 325mm in 5mm steps
- max. load 25kg
- weight: 223g

delivery

- incl. screw M 10x20 and spring washer F6 (galvanized)
- clamp optional
- kickstand shoe F13 or F14 optional

material

- Aluminium die cast GD-ALSi9Cu3

colour

- powder coated black or metallic silver
- polished



Optima center kickstand

properties

- push spring movement
- length 265 - 350mm in 5mm steps
- high stability
- max. load 25kg
- weight: 254g

delivery

- incl. screw M 10x20 and spring washer F6 (galvanized)
- clamp optional
- kickstand shoe F13 or F14 optional

material

- Aluminium die cast GD-ALSi9Cu3

colour

- powder coated black or metallic silver



Zoom center kickstand

properties

- push spring movement
- expendable in 7.5mm steps
- max. load 18kg
- weight: 240g
- strut length: 26-29"

delivery

- incl. screw M 10x20 and spring washer F6 (galvanized)
- clamp optional
- Plastic shoe with large platform

material

- Aluminium die cast GD-ALSi9Cu3

colour

- powder coated black or metallic silver

Advantages: Easy mounting. High stability. Wide support angle. Push spring controlled movement. Aluminium die cast. Steel pin, hardened and zinc galvanized.



more stability



Twin center kickstand

properties

- push spring movement
- max. load 25kg
- weight: 542g
- strut length: 290 (S) or 320mm (L)

delivery

- incl. screw M 10x20 and spring washer
- clamp optional for AFM
- kickstand shoe optional (F24)

material

- Aluminium die cast GD-ALSi9Cu3

colour

- powder coated black or metallic silver



Comp 18 rear kickstand

properties

- Pivoting movement over spring
- length 265 - 350mm in 5mm steps
- max. load 25kg
- weight: 268g
- kickstand for direct mounting

delivery

- screw M 5 or M 6
- kickstand shoe F13 or F14 optional

material

- Aluminium die cast GD-ALSi9Cu3

colour

- powder coated black or metallic silver



Comp 18 Zoom rear kickstand

properties

- push spring movement
- adjustable in steps of 7.5mm
- max. load 18kg
- weight: 260g
- strut length: 26-29"

delivery

- screws M 5x20
- Plastic shoe with large platform

material

- aluminium die cast GD-ALSi9Cu3

colour

- powder coated black or metallic-silver



ESGE-KICKSTANDS SWISS MADE



Comp 40 rear kickstand

properties

- push spring movement
- max. load 25kg
- weight: 295g
- length: 265 - 350mm
- kickstand for direct mounting

delivery

- screw M 5 or M 6
- kickstand shoe F13 or F14 optional

material

- Aluminium die cast GD-ALSi9Cu3

colour

- powder coated black or metallic silver



Comp 40 Zoom rear kickstand

properties

- push spring movement
- adjustable in steps of 7.5mm
- max. load 18kg
- weight: 275g
- stru length: 26-29"

delivery

- screws M 6x20
- Plastic shoe with large platform

material

- aluminium die cast GD-ALSi9Cu3

colour

- powder coated black or metallic-silver



Multi rear kickstand

properties

- push spring movement
- max. load 25kg
- weight: 433g
- strut length: 26" - 29"
- aluminium die cast GD-ALSi9Cu3
- big range for adjusting for near all frames

delivery

- mounting parts with screws and straps
- kickstand shoe F13 or F14 optional

material

- aluminium die cast GD-ALSi9Cu3

colour

- powder coated black or metallic-silver

Advantages: Easy mounting. High stability. Wide support angle. Push spring controlled movement. Aluminium die cast. Steel pin, hardened and zinc galvanized.



MORE STABILITY



LENGTH MEASUREMENT

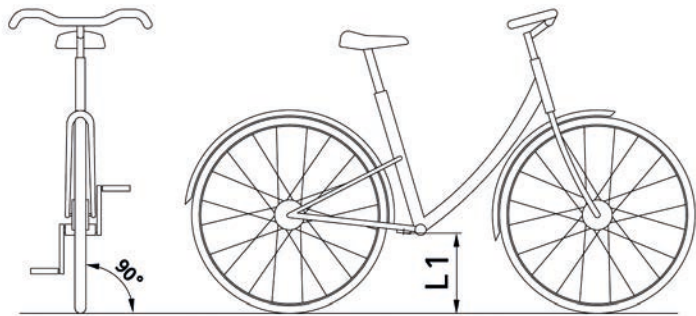

MULTI MOUNTING

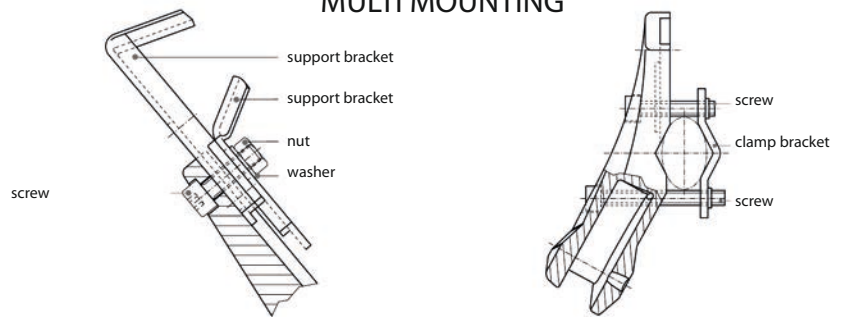

Multi Zoom
rear kickstand

properties

- push spring movement
- adjustable in steps of 7.5mm
- max. load 18kg
- weight: 340g
- strut length: 26-29"

delivery

- mounting parts with screws and straps
- Plastic shoe with large platform

material

- aluminium die cast GD-AlSi9Cu3

colour

- powder coated black or metallic-silver

PATENTED
SPRING MECHANISM

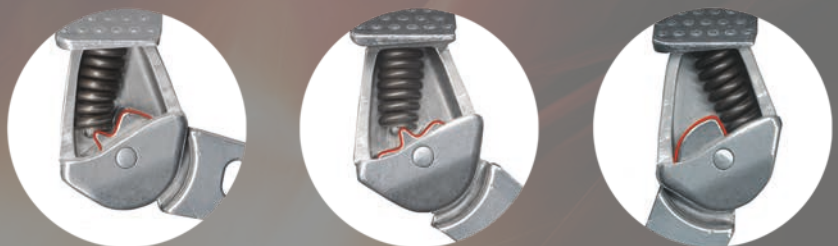

PATENTED
DAMPING MECHANISM





ESGE- KICKSTANDS SWISS MADE

ADJUSTABLE IN LENGTH



Optima Flex center kickstand adjustable in length

properties

- push spring movement
- max. load 50kg
- weight: 303g
- strut length: 210 - 375 mm

delivery

- screws for mounting
- sliding shell with F18 kickstand shoe

material

- Aluminium die cast GD-ALSi9Cu3

colour kickstand

- powder coating black or metallic-silver

colour sliding shell

- black, white, red, silver, titan

Comp 18 Flex rear kickstand adjustable in length

properties

- push spring movement
- max. load 50kg
- weight: 350g
- strut length: 210 - 375 mm

delivery

- screws for mounting
- sliding shell with F18 kickstand shoe

material

- Aluminium die cast GD-ALSi9Cu3

colour kickstand

- powder coating black or metallic-silver

colour sliding shell

- black, white, red, silver, titan

Comp 40 Flex rear kickstand adjustable in length

properties

- push spring movement
- max. load 50kg
- weight: 360g
- strut length: 210 - 375 mm

delivery

- screws for mounting
- sliding shell with F18 kickstand shoe

material

- Aluminium die cast GD-ALSi9Cu3

colour kickstand

- powder coating black or metallic-silver

colour sliding shell

- black, white, red, silver, titan



ESGE-FAHRRADSTÜTZEN SWISS MADE



Multi Flex rear kickstand adjustable in length

properties

- push spring movement
- max. load 50kg
- weight: 450g
- strut length: 210 - 375 mm

delivery

- screws for mounting
- sliding shell with F18 kickstand shoe

material

- Aluminium die cast GD-ALSi9Cu3

colour kickstand

- powder coating black or metallic-silver

colour sliding shell

- black, white, red, silver, titan



sliding shells for Flex kickstands with 45 ° cut part

- weight: 61 g
- length shell: 110mm

delivery

- screw M 5 x 8mm with screw lock
- F18 kickstand shoe

material

- aluminium-pull profile

colour: powder coated

black

white
red
silver
titan



ESGE-KICKSTANDS SWISS MADE



Optima ARA center kickstand

properties

- swing range over exterior tension spring
- kickstand pops up automatically if the bike is released from the standing position
- max. load 25kg
- weight: 295g
- strut length: 265 - 350 mm

delivery

- mounting screw M 10
- kickstand shoe F13 or F14 optional
- assembly kit including tension spring, bracket and screws

material

- aluminium die cast GD-AISI9Cu3

colour

- powder coated black or metallic silver



Comp 18 ARA rear kickstand

properties

- swing range over exterior tension spring
- kickstand pops up automatically if the bike is released from the standing position
- max. load 25kg
- weight: 275g
- strut length: 265 - 350mm

delivery

- mounting screws M 5 or M 6
- kickstand shoe F13 or F14 optional
- assembly kit including tension spring, bracket and screws

material

- aluminium die cast GD-AISI9Cu3

colour

- powder coated black or metallic silver



Comp 40 ARA rear kickstand

properties

- swing range over exterior tension spring
- kickstand pops up automatically if the bike is released from the standing position
- max. load 25kg
- weight: 290g
- strut length: 265 - 350mm

delivery

- mounting screws M 5 or M 6
- kickstand shoe F13 or F14 optional
- assembly kit including tension spring, bracket and screws

material

- aluminium die cast GD-AISI9Cu3

colour

- powder coated black or metallic silver



KICKSTAND MOUNTING PARTS

clamp F15/3

with counter sunk screw

application

- Zoom
- Standard
- Optima
- Twin

delivery

- clamp F15/3
- countersunk screw M 10x55

material

- clamp aluminium-die cast GD-ALSi9Cu3
- screw galvanized

colour

- powder coated black or polished

specification

- dimension 53x26x14 / Ø10.5 (mm)



clamp F15/1

with allen screw and capping nut

application

- Zoom
- Standard
- Optima
- Twin

delivery

- clamp F15/1
- allen screw M 8x60
- capping nut

material

- clamp aluminium-die cast GD-ALSi9Cu3
- screw galvanized

colour

- powder coated black or polished

specification

- dimension 53x17x21 / Ø8.5 (mm)



clamp F15/4

with hexagon screw and washer

application

- Zoom
- Standard
- Optima
- Twin

delivery

- clamp F15/4
- hexagon screw M 10x55
- washer

material

- clamp aluminium-die cast GD-ALSi9Cu3
- screw galvanized

colour

- powder coated black or polished

specification

- dimension 53x26.2x13.8 / Ø10.5 (mm)



clamp F7

with hexagon screw and washer

application

- Zoom
- Standard
- Optima
- Twin

delivery

- clamp F7
- hexagon screw M 10x65
- washer

material

- clamp aluminium GD-ALSi9Cu3
- screw galvanized

colour

- powder coated black or polished

specification

- dimension 62x30x14 / Ø10.5 (mm)





KICKSTAND MOUNTING PARTS



CLAMP F8 for TWIN with hexagon screw and washer

application
 • for all center kickstands

delivery
 • clamp F8
 • two plastic saddles
 • hexagon screw M10x65
 • washer

material
 • clamp aluminium- GD-ALSi9Cu3
 • screw galvanized

colour
 • shiny or powder coating black

specification
 • dimension 55x30x14 / Ø10.5 (mm)



chain stay cross plate for OEM use

application
 • for all center kickstands • Standard
 • Optima

delivery
 • steel plate

material
 • steel shiny

specification
 • dimension 60x43.75 (mm)



clamp F20 for bikes for the Netherlands with allen screw and capping nut

application
 • for all center kickstands • Standard
 • Optima

delivery
 • clamp F20
 • allen screw M8x35
 • capping nut

material
 • aluminium
 • screw galvanized
 • shiny

specification
 • dimension 56x33.5x10 / Ø10.4 (mm)

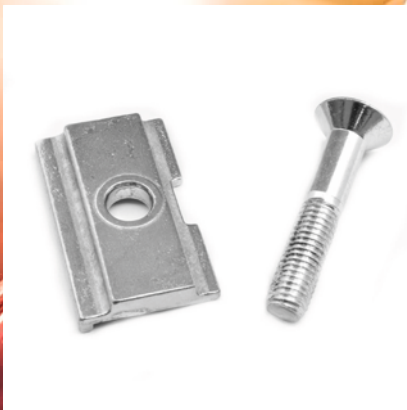

clamp F20/1 for bikes from the Netherlands with counter sunk screw

application
 • for all center kickstands • Standard
 • Optima

delivery
 • clamp F20/1
 • counter sunk screw M10x55

material
 • aluminium
 • screw galvanized
 • shiny

specification
 • dimension 56x33.5x10 / Ø10.4 (mm)



weld-on chain stay plate aluminium for Comp 18 kickstands

For welding to chain stay 18mm

application

- Comp 18
- Comp 18 Zoom

delivery

- weld-on chain stay plate aluminium

material

- aluminium

colour

- polished

specification

- thread M 5
- dimension 29x10.6x8 (mm)

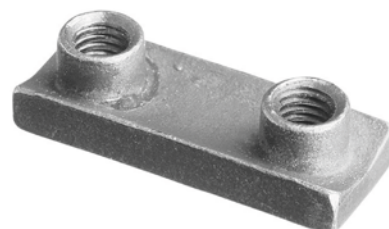

weld-on chain stay plate steel for Comp 18 kickstands

For welding to chain stay 18mm

application

- Comp 18
- Comp 18 Zoom

delivery

- weld-on chain stay plate aluminium

material

- steel

colour

- shiny

specification

- thread M 5
- dimension 29x10.6x8 (mm)



adapter plate for Comp 18 kickstands

18/40 - 18/18

application

- Comp 18
- Comp 18 Zoom

delivery

- adapter plate 18/40 or 18/18

material

- steel polished

specification

- dimension hole distance 18/40 or 18/18



sliding flap for M ulti kickstand

with opposite flap

application

- Multi
- Multi Zoom

delivery

- sliding flap
- opposite flap
- mounting parts

material

- steel galvanized

colour

- black coated





KICKSTAND MOUNTING PARTS



wedge to increase the angle

- application
- Standard
 - Optima
 - Optima Flex
 - Zoom

- material
- aluminium GD 226 (AlSi9Cu3)

- colour
- polish
 - black



crank protection Pletscher

- application
- Optima
 - Standard

- material
- polyurethane

- colour
- black or silver

- specification
- length 80mm



kickstand shoe for Zoom kickstands Zoom (spare part)

- application
- Zoom
 - Comp 18 Zoom, Comp 40 Zoom
 - Multi Zoom

- material
- polyurethane

- colour
- black



kickstand shoe

F13

application

- Optima
- Standard
- Comp 18, Comp 40
- Multi

material

- polyurethane

colour

- black



kickstand shoe

F14

application

- Optima
- Standard
- Comp 18, Comp 40
- Multi

material

- polyurethane

colour

- black or silver



kickstand shoe

F18 (spare part)

application

- Optima Flex
- Comp 18 Flex
- Comp 40 Flex
- Multi Flex

material

- polyurethane

colour

- black



kickstand shoe pair for TWIN

F24

application

- Twin

material

- polyurethane

colour

- black





AGENCIES & DISTRIBUTORS

Schweiz

Pletscher AG
Obere Schilling 4
CH-8460 Marthalen
Phone: +41 52 305 46 46
Fax: +41 52 305 46 40
E-Mail: info@pletscher.ch
Web: www.pletscher.ch

Deutschland

Österreich
Dänemark
Sandmann Industrivertretungen CDH
Rehbecke 1
DE-58091 Hagen
Phone: +49 2337 48595-0
E-Mail: info@ses-sandmann.de
Web: www.ses-sandmann.de

Niederlande

Buzaglo B.V.
Rondelbeltweg 20
NL 1329 Ba Almere
Phone: +31 36 521 0100
E-Mail: info@buzaglo.nl
Web: www.buzaglo.nl

Belgien

Luxemburg
Intercycle NV
Kleinewinkellaan 22
BE-1853 Strombeek-Bever
Phone: +32 2 569 13 96
Fax: +32 2 569 21 50
E-Mail: info@intercycle.be
Web: www.intercycle.be

Frankreich

Guyonneau Freres Sarl
Quartier Saute Lievre
FR-13490 Jouques
Phone: +33 4 426 37 287
Fax: +33 4 426 36 234
E-Mail: guyonneau.sarl@wanadoo.fr

England

Wildoo Ltd.
39 Barton Road
Water Eaton Ind Est
Bletchley
Bucks
MK2 3HW. U.K.
Phone: +44 1908 374 555
Fax: +44 8701 991 614
E-Mail: andy@wildoo.co.uk
Web: www.wildoo.co.uk

Japan

Unico Corp.
1-4-22 Nakakoyo, Sakai-Ku, Sakai
Osaka, 590-0072 Japan
Phone: +81-72-232-8175
Fax: +81-72-232-8176
Web: www.unico-jp.com

Tschechische Republik

IMEXPO spol.s.r.o
Kolbenova 159/7
CZ-190 00 Praha 9
Phone: +420 226 311 466
Fax: +420 266 311 460
E-Mail: info@imexpo.cz
Web: www.imexpo.cz

Polen

Alpin Bike
Krzysztof Polak
ul. Kołtątaja 3
PL-48-100 Głubczyce
Phone: +48 (77) 403 68 23
Fax: +48 (77) 555 80 72
E-Mail: info@alpinbike.pl
Web: www.alpinbike.pl

USA

KHS Bicycle Parts, Inc.
3550 N. Union Drive
Olney, IL.62450, USA
Phone: +1 618 393 2955
Fax: +1 618 393 2956
E-mail consumer: sales@thorusa.com
E-mail dealer: sharon@khsbicycleparts.com
Web: <http://www.thorusa.com>

Australien

Joad Sportz Supplies
Carlisle Street 9
AU-2037 Collaroy Plateau
Sidney NWS
Phone: +61 2 9982 3227
Fax: +61 2 9982 3227
E-Mail: info@joadsportzsupplies.com.au
Web: www.joadsportzsupplies.com.au

Republik Süd - Korea

IL International
2F Kyunghee Bldg, Anyang 3dong,
Mananku, Anyangshi, Kyunggido,
Republic of Korea
Phone: +82 31 383 09 31
Fax: +82 31 383 09 40
E-Mail: roybang@citybike.co.kr
Web: www.citybike.co.kr

Finnland

Schweden
OY Brink Consulting AB
P.O. Box 593
FI-00101 Helsinki
Phone: +358 9 505 52 00
Fax: +358 9 505 54 50
E-Mail: anders.brink@brink.fi

Norwegen

Deler AS
Hestehagen 4
NO - 1448 Drøbak
Phone: +47 64 98 99 50
email: post@deler.no
Web: <http://www.deler.no>